

**Steek**

**Lameltype**

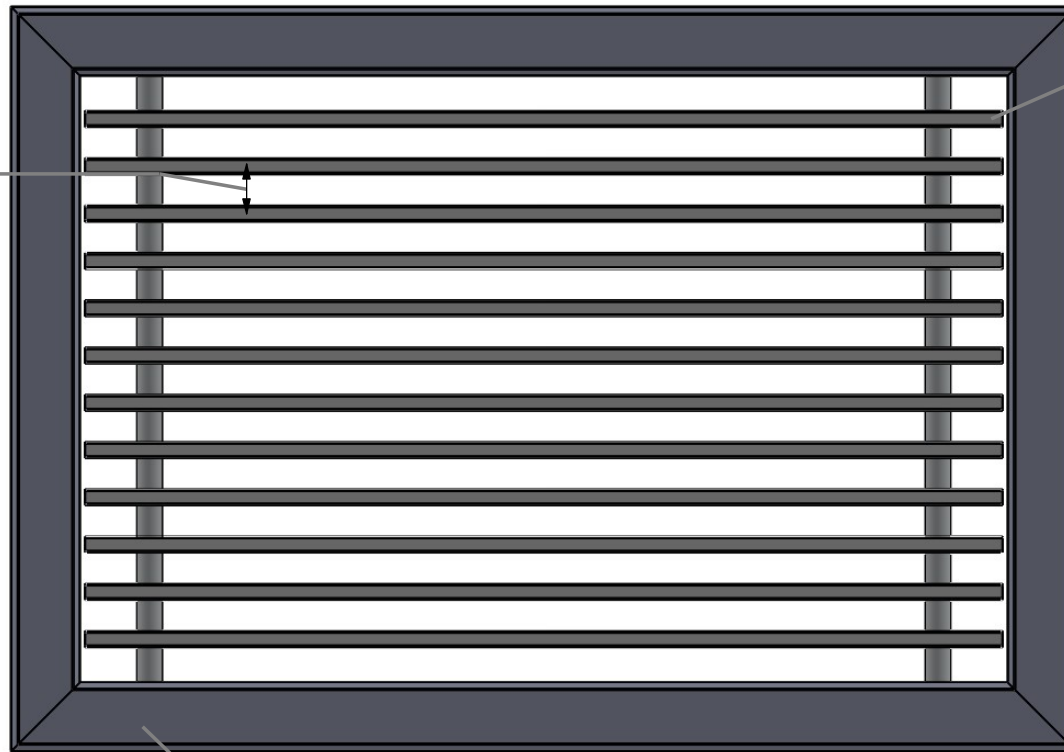

15

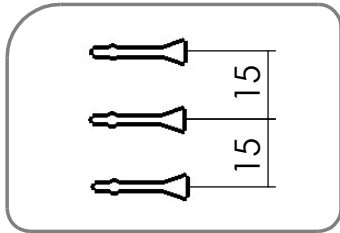

11

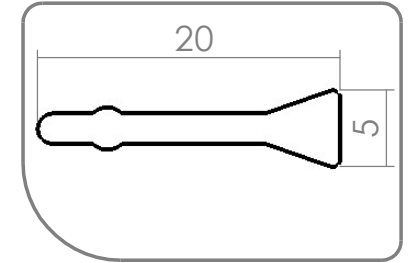
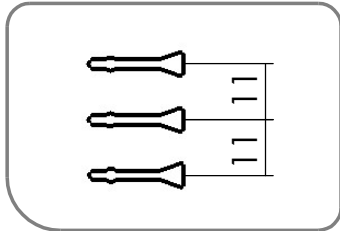

LA

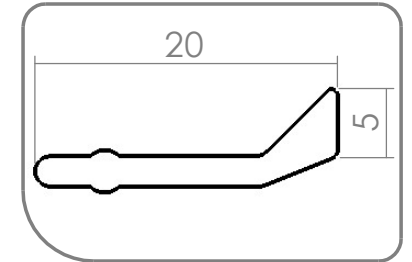

LB

**Kadertype**

**A**

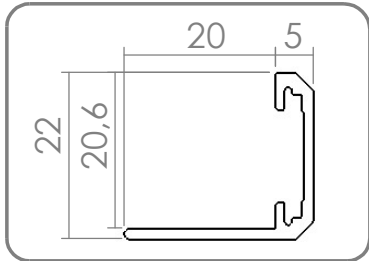

**B**

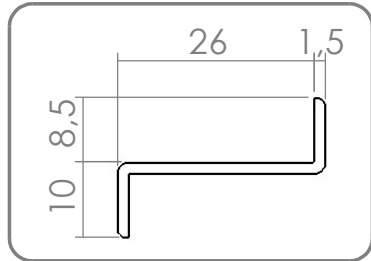

**C**

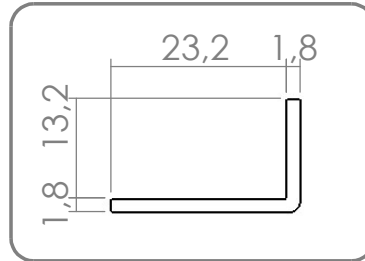

**D**

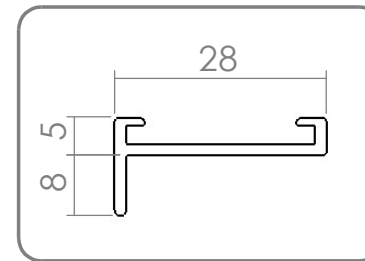

**E**

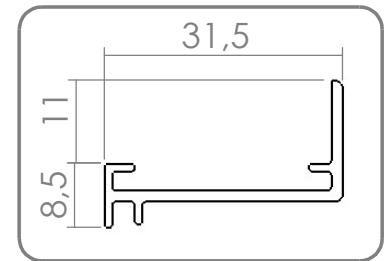

**SG54ALA15**

**STEEK**

**LAMELTYPE**

**KADERTYPE**



GAVO VENTILATIE		GAVO CONCEPTS	
Naam	Handtekening	Datum	Materiaal:
Getekend	T. Doornhein	9-7-18	Naam tekening:
Gecontroleerd			<b>SG54 Overzicht</b>
Goedgekeurd			Gewicht:
			Tolerantie: Volgens GAVO AT01
			SCALE:1:5
			SHEET 1 OF 1
			A4

# Sparingmaten

Popnagels



Maten gelden voor kadertype: A, B, C

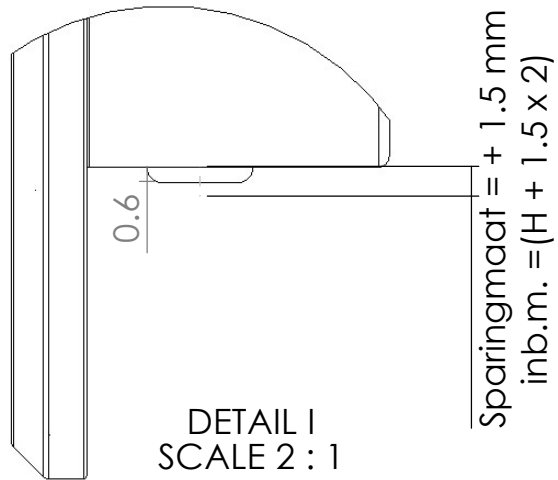
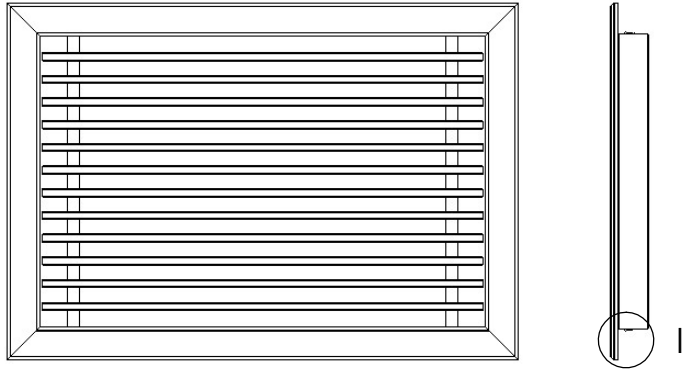

Optioneel: Klemveren

Maten gelden voor elke kadertype  
geldt ook voor breedtematen

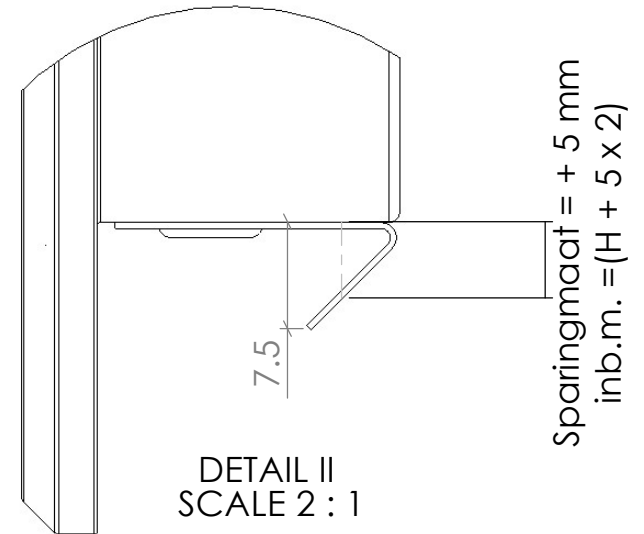
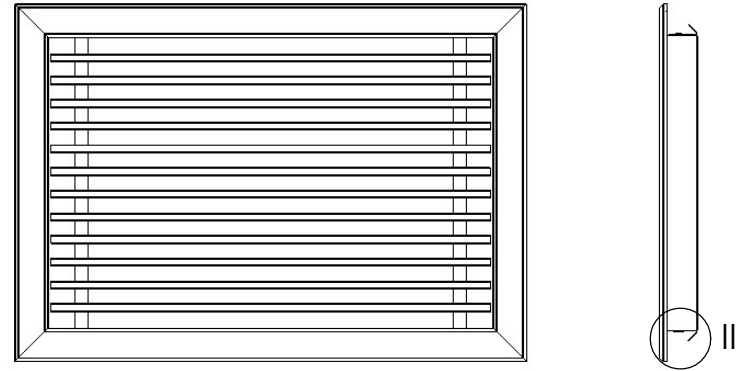
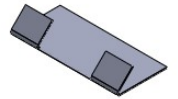

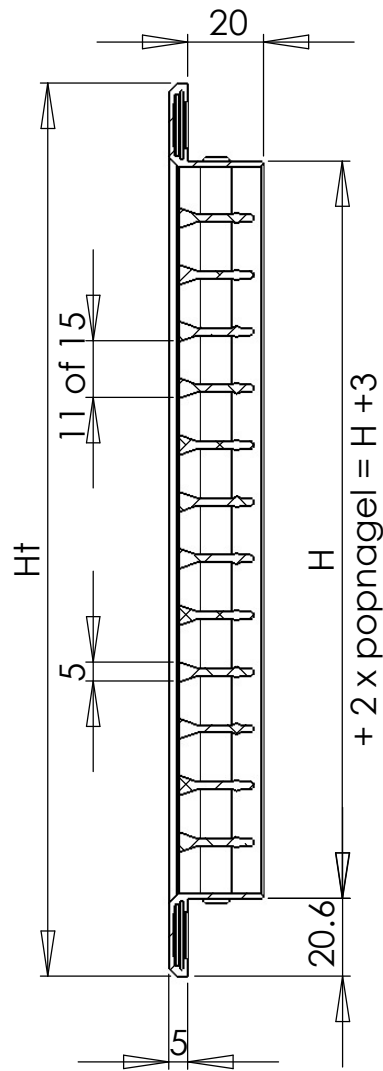

	Naam	Handtekening	Datum	Materiaal:	Naam tekening:
Getekend	T. Doornhein		20-12-2018		<b>SG54 Sparingmaten</b>
Gecontroleerd				Gewicht:	Tolerantie: Volgens GAVO AT01
Goedgekeurd				SCALE:1:5	A4 SHEET 1 OF 1

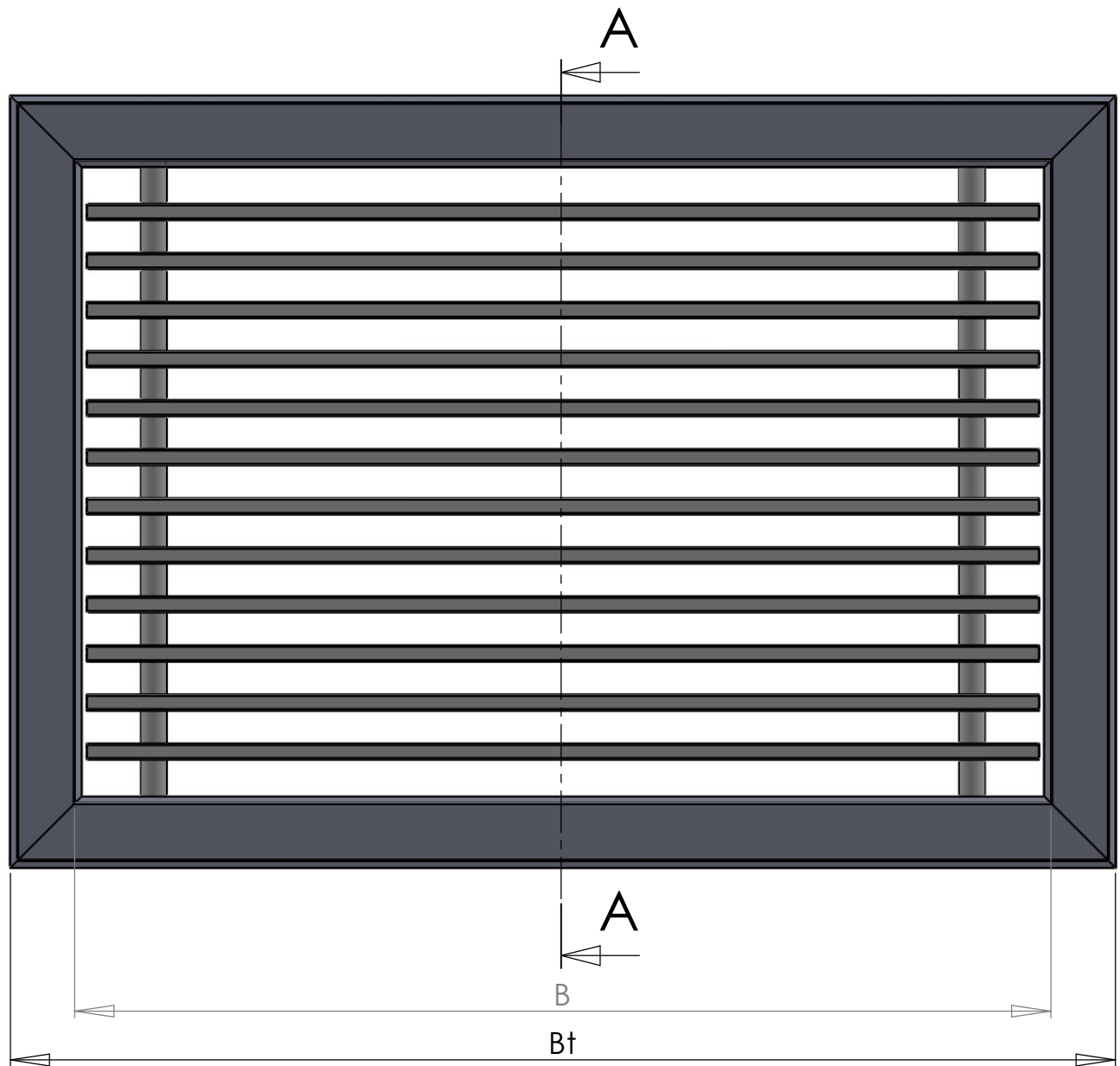

+ 2 x popnagel = H + 3

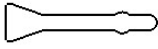
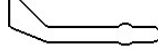

Lamel LA 1:1		Lamel LB 1:1	
Lamelsteek verkrijgbaar in 11 mm en 15 mm			
Voor verdere configuraties zie: SG54 Overzicht			

			
Getekend	Naam	Handtekening	Datum
Gecontroleerd	T. Doornhein		9-7-18
Goedgekeurd			
Materiaal:		Naam tekening:	
Gewicht:		<b>SG54ALA15</b>	
SCALE:1:2		Tolerantie: Volgens GAVO AT01	
		A4	
		SHEET 1 OF 1	

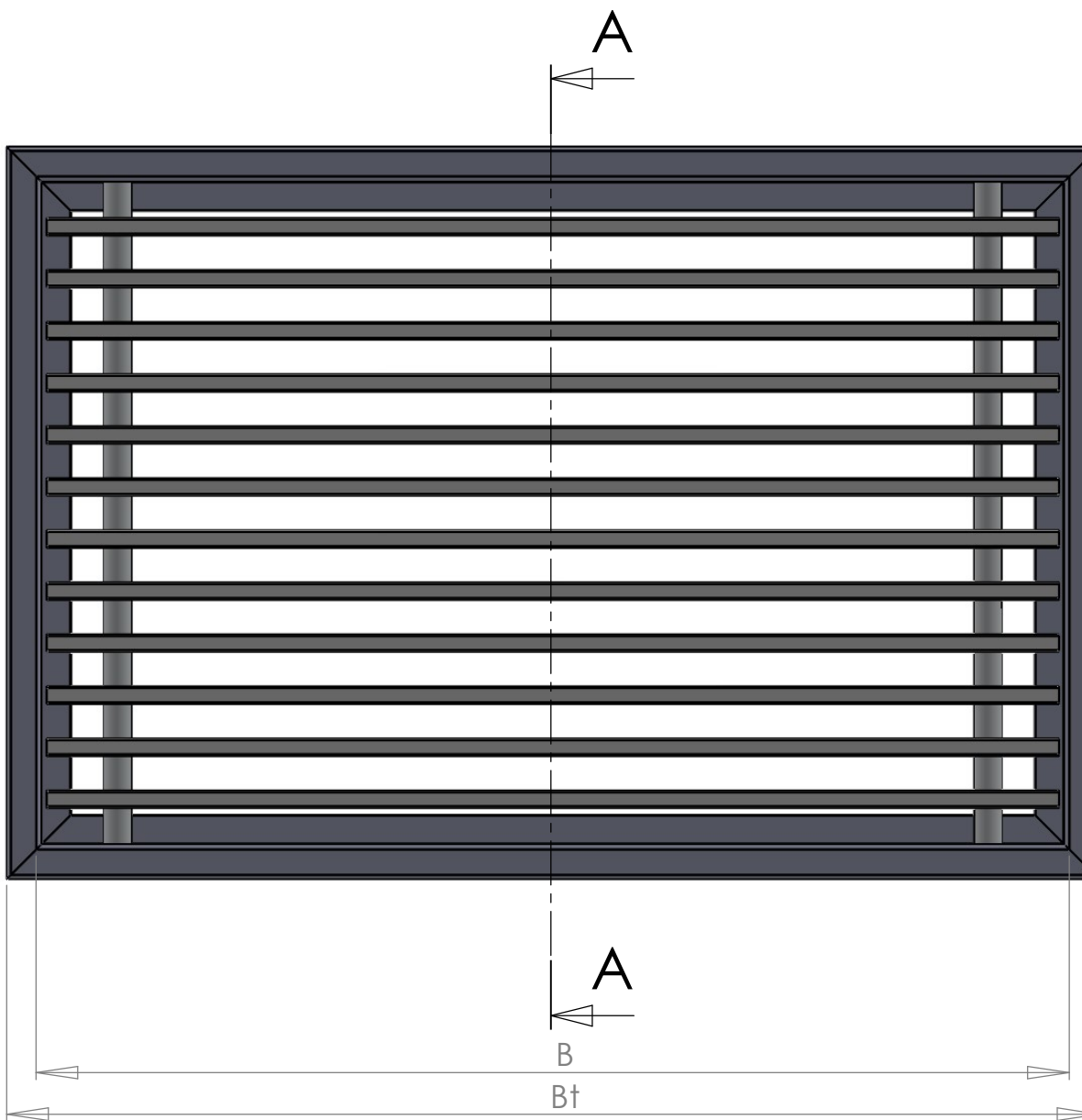
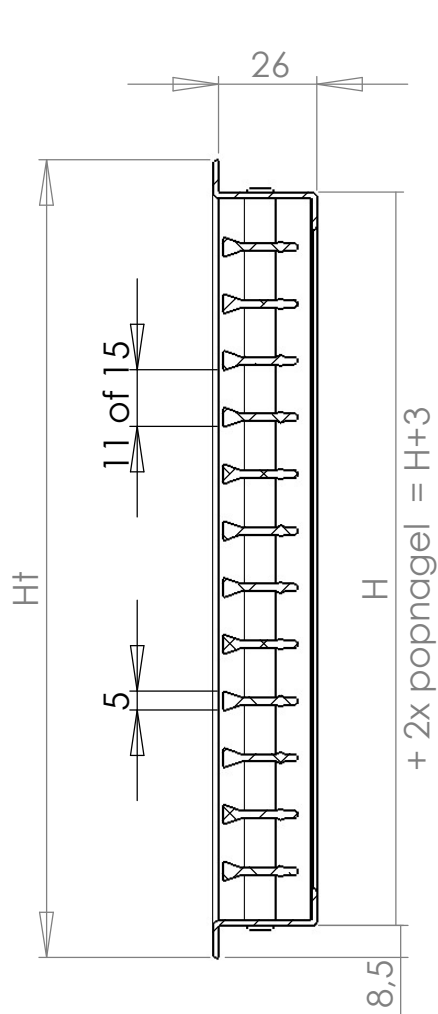

Lamel LA  
1:1

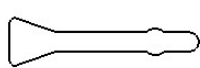

Lamel LB  
1:1

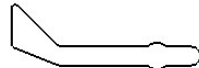

Lamelsteek verkrijgbaar in 11 mm en 15 mm

Voor verdere configuraties zie: SG54 Overzicht





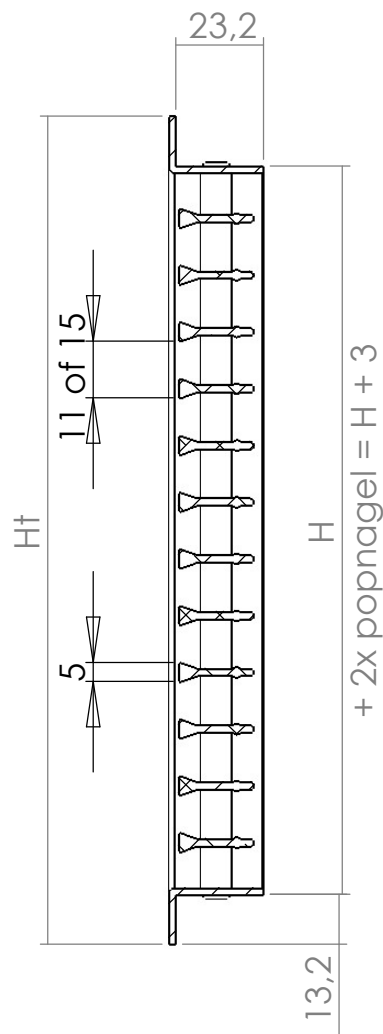

	Naam	Handtekening	Datum	Materiaal:	Naam tekening:
Getekend	T. Doornhein		19-7-18		<b>SG54BLA15</b>
Gecontroleerd				Gewicht:	Tolerantie: Volgens GAVO AT01
Goedgekeurd				SCALE:1:2	A4 SHEET 1 OF 1

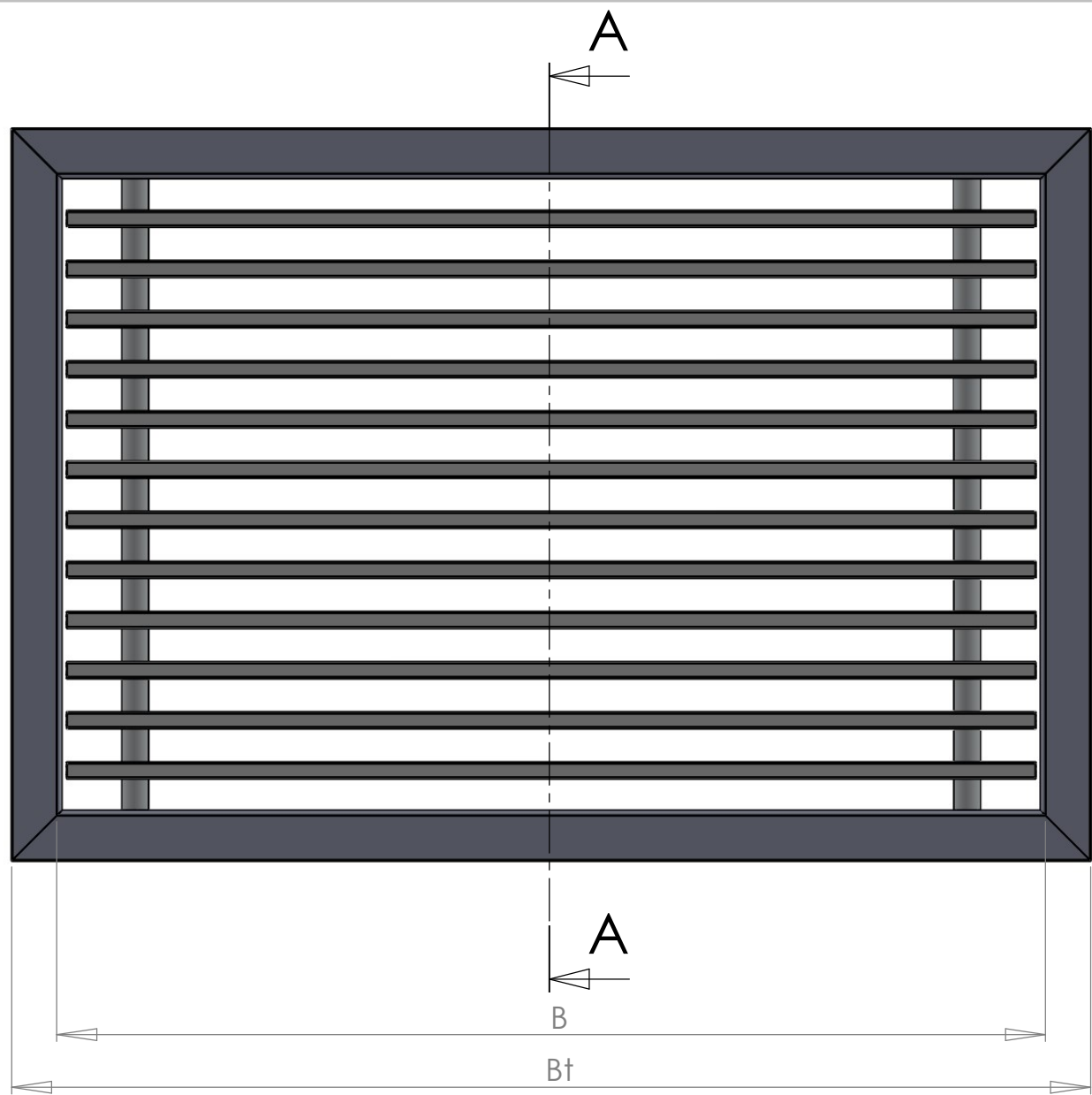

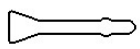
+ 2x popnagel = H + 3



Lamel LA 1:1		Lamel LB 1:1	
Lamelsteek verkrijgbaar in 11 mm en 15 mm			
Voor verdere configuraties zie: SG54 Overzicht			

			
Getekend	Naam	Handtekening	Datum
Gecontroleerd	T. Doornhein		19-7-18
Goedgekeurd			
Materiaal:		Naam tekening:	
Gewicht:		SG54CLA15	
SCALE:1:2		Tolerantie: Volgens GAVO AT01	
		A4	
		SHEET 1 OF 1	

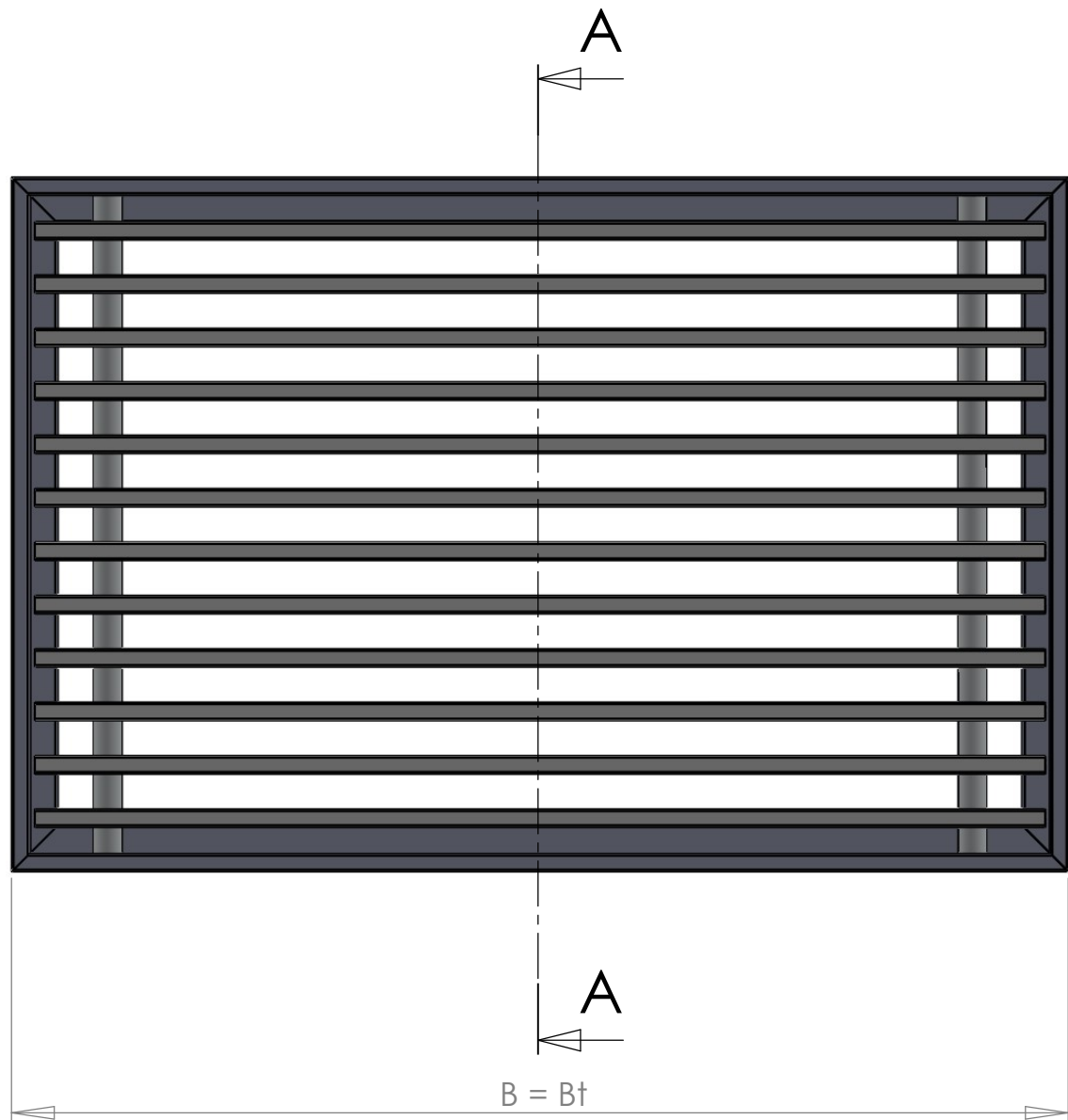
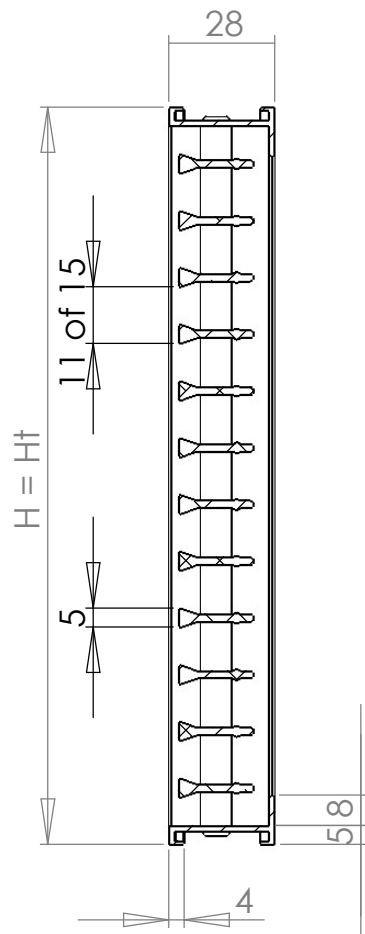

Lamel LA  
1:1

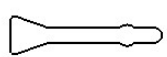

Lamel LB  
1:1

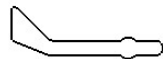

Lamelsteek verkrijgbaar in 11 mm en 15 mm

Voor verdere configuraties zie: SG54 Overzicht



	Naam	Handtekening	Datum	Materiaal:	Naam tekening:	
Getekend	T. Doornhein		19-7-18		<b>SG54DLA15</b>	
Gecontroleerd				Gewicht:	Tolerantie: Volgens GAVO AT01	A4
Goedgekeurd				SCALE:1:2	SHEET 1 OF 1	

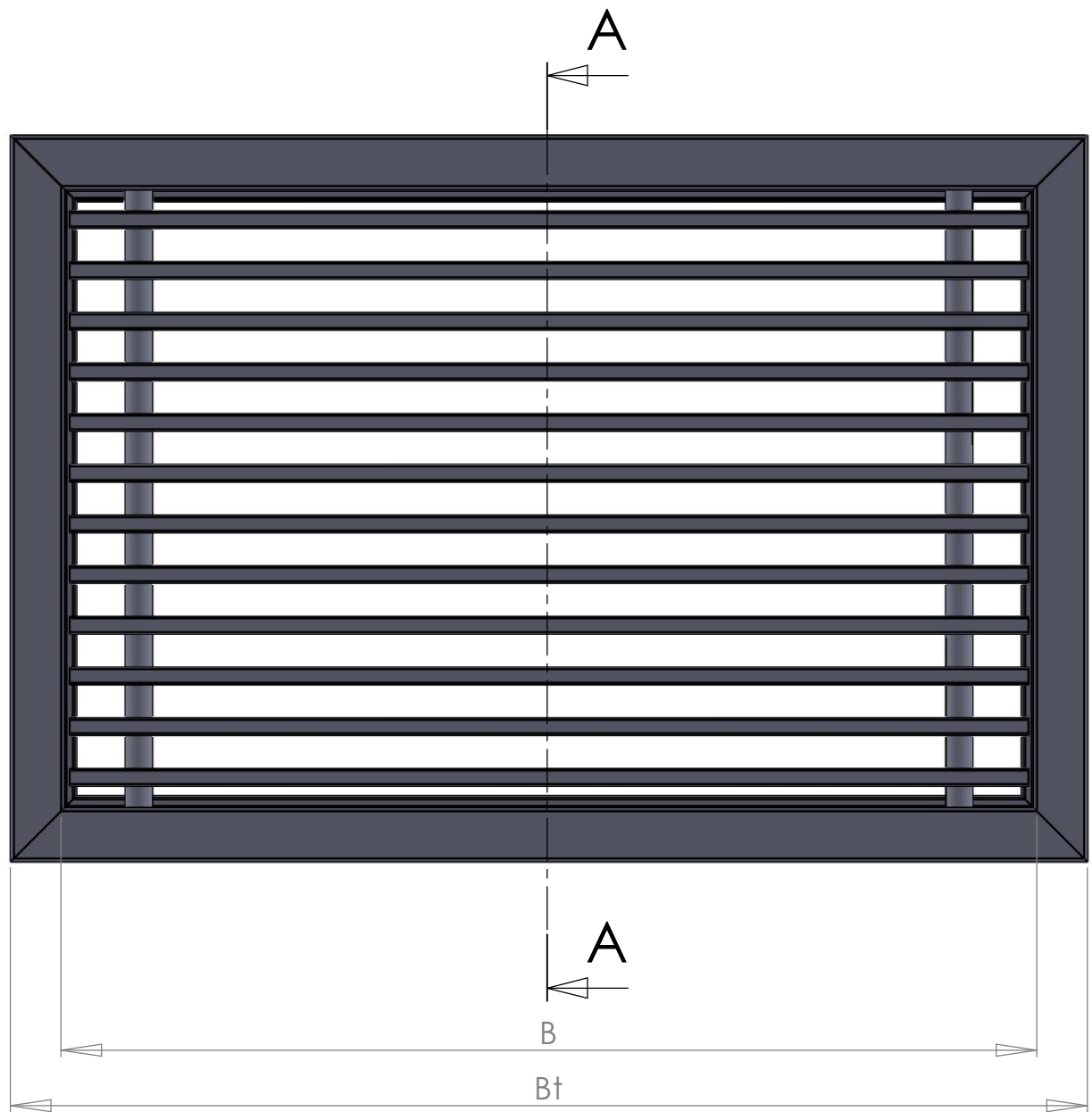
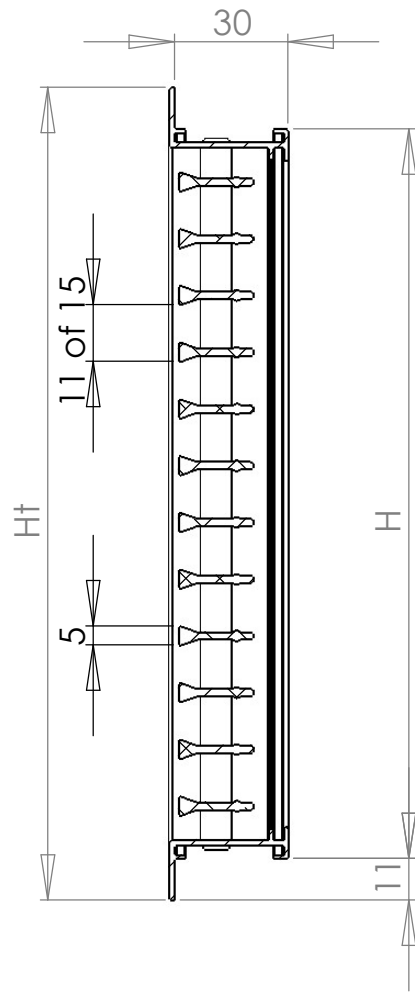

Lamel LA  
1:1

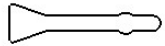

Lamel LB  
1:1

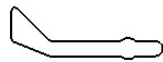

Lamelsteek verkrijgbaar in 11 mm en 15 mm

Voor verdere configuraties zie: SG54 Overzicht



	Naam	Handtekening	Datum	Materiaal:	Naam tekening:
Getekend	T. Doornhein		19-7-18		<b>SG54ELA15</b>
Gecontroleerd				Gewicht:	Tolerantie: Volgens GAVO AT01
Goedgekeurd				SCALE:1:2	A4 SHEET 1 OF 1

# SGX-KVS

## Set: 4x

### For Frametype A and C

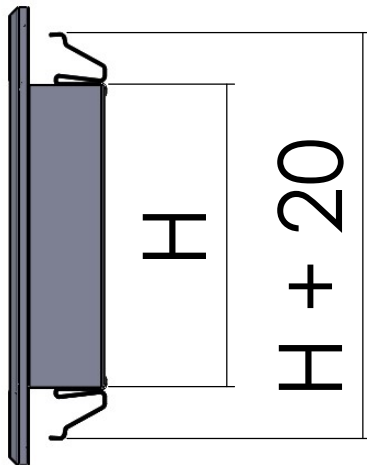
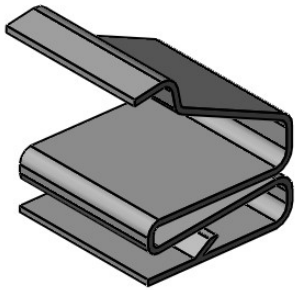

**GAVO VENTILATIE**

**GAVO CONCEPTS**

	Naam	Handtekening	Datum	Materiaal:	Naam tekening: <b>SGX-KVS</b>	
Getekend	Ing. T. Doornhein		7-2-2020	Gewicht:	Tolerantie: Volgens GAVO AT01	A4
Gecontroleerd				SCALE:1:2	SHEET 1 OF 1	
Goedgekeurd						



# Steek 11 Lameltype A

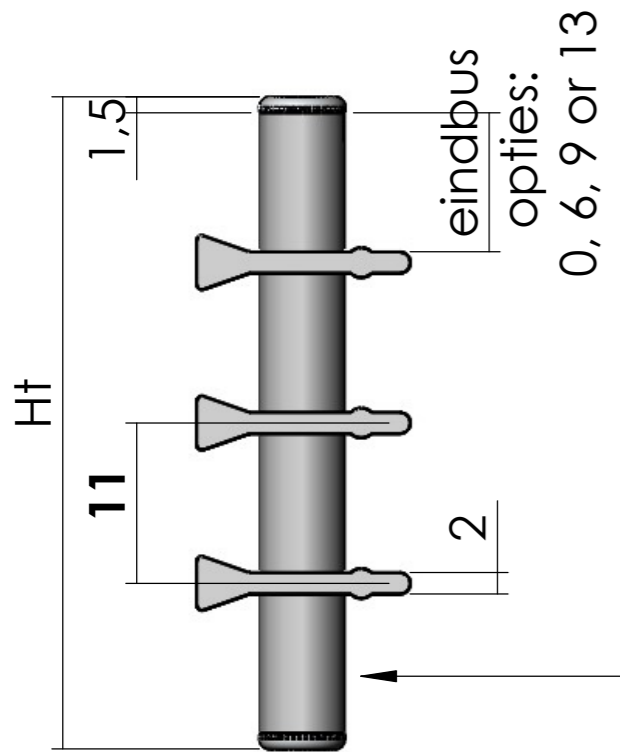

Steek 11																			
Aantal stappen	2	3	4	5	6	7	8	9	10	11	12	13	14	15	16	17	18	19	20
Stappen x steek	22	33	44	55	66	77	88	99	110	121	132	143	154	165	176	187	198	209	220
Zonder eindbus (+5)	27	38	49	60	71	82	93	104	115	126	137	148	159	170	181	192	203	214	225
eindbus 6 mm (+17)	39	50	61	72	83	94	105	116	127	138	149	160	171	182	193	204	215	226	237
eindbus 9 mm (+23)	45	56	67	78	89	100	111	122	133	144	155	166	177	188	199	210	221	232	243
eindbus 13 mm (+31)	53	64	75	86	97	108	119	130	141	152	163	174	185	196	207	218	229	240	251

Steek 11																						
21	22	23	24	25	26	27	28	29	30	31	32	33	34	35	36	37	38	39	40	41	42	43
231	242	253	264	275	286	297	308	319	330	341	352	363	374	385	396	407	418	429	440	451	462	473
236	247	258	269	280	291	302	313	324	335	346	357	368	379	390	401	412	423	434	445	456	467	478
248	259	270	281	292	303	314	325	336	347	358	369	380	391	402	413	424	435	446	457	468	479	490
254	265	276	287	298	309	320	331	342	353	364	375	386	397	408	419	430	441	452	463	474	485	496
262	273	284	295	306	317	328	339	350	361	372	383	394	405	416	427	438	449	460	471	482	493	504



Getekend	Naam Ing. T. Doornhein	Handtekening	Datum 22-6-2020	Materiaal:	Naam tekening: <b>SG54 Hoogtematen</b>	
Gecontroleerd				Gewicht:	Tolerantie: Volgens GAVO AT01	A4
Goedgekeurd				SCALE:1:1	SHEET 1 OF 2	

## Steek 15 Lameltype A

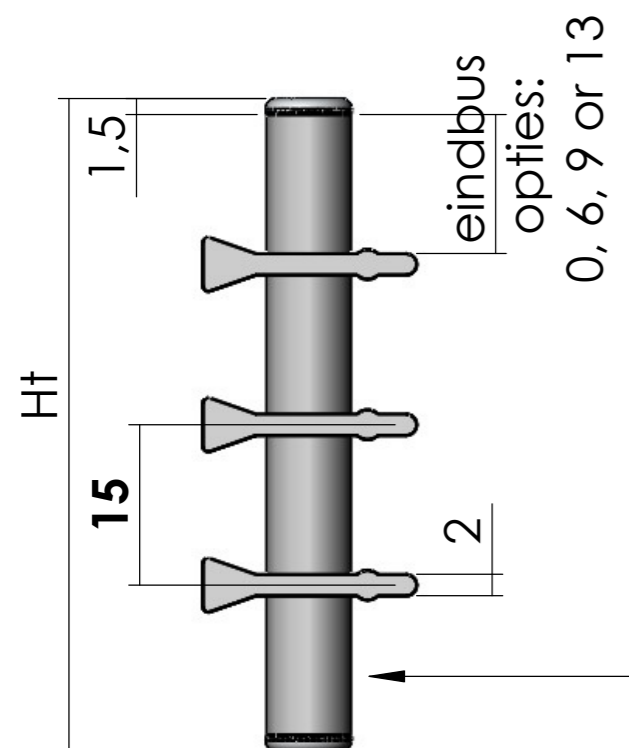

Steek 15																			
Aantal stappen	2	3	4	5	6	7	8	9	10	11	12	13	14	15	16	17	18	19	20
Stappen x steek	30	45	60	75	90	105	120	135	150	165	180	195	210	225	240	255	270	285	300
Zonder eindbus (+5)	35	50	65	80	95	110	125	140	155	170	185	200	215	230	245	260	275	290	305
eindbus 6 mm (+17)	47	62	77	92	107	122	137	152	167	182	197	212	227	242	257	272	287	302	317
eindbus 9 mm (+23)	53	68	83	98	113	128	143	158	173	188	203	218	233	248	263	278	293	308	323
eindbus 13 mm (+31)	61	76	91	106	121	136	151	166	181	196	211	226	241	256	271	286	301	316	331

Steek 15												
21	22	23	24	25	26	27	28	29	30	31	32	
315	330	345	360	375	390	405	420	435	450	465	480	
320	335	350	365	380	395	410	425	440	455	470	485	
332	347	362	377	392	407	422	437	452	467	482	497	
338	353	368	383	398	413	428	443	458	473	488	503	
346	361	376	391	406	421	436	451	466	481	496	511	



	Naam	Handtekening	Datum	Materiaal:	Naam tekening: <b>SG54 Hoogtematen</b>	
Getekend	Ing. T. Doornhein		22-6-2020		Tolerantie: Volgens GAVO AT01	A4
Gecontroleerd				Gewicht:		
Goedgekeurd				SCALE:1:1	SHEET 2 OF 2	